

Battery
Operated

FIREX[®]

Smoke Alarm



**MODELS A, B, C,
E AND PB**

110-644

**PLEASE READ AND SAVE
THIS MANUAL**

Installer: Please leave this
manual with the product.



!WARNING: THIS SMOKE ALARM WILL SOUND A SHORT BEEP WHEN POWER IS CONNECTED.

DO NOT USE THIS SMOKE ALARM WITH ANY EXTERNAL BUG SCREENS OR SMOKE ALARM GUARDS. USE OF THESE TYPES OF DEVICES MAY REDUCE SMOKE ALARM RESPONSE TIME.

CONTENTS

p.1-2	IMPORTANT INFORMATION ABOUT YOUR SMOKE ALARM
p.2	WHAT SMOKE ALARMS CAN DO
p.2-3	WHAT SMOKE ALARMS WILL NOT DO
p.3-5	WHERE YOU SHOULD INSTALL YOUR SMOKE ALARMS
p.5	SPECIAL DIRECTIONS FOR INSTALLING YOUR SMOKE ALARM IN MANUFACTURED AND MOBILE HOMES
p.5-6	WHERE YOU SHOULD NOT INSTALL SMOKE ALARMS
p.6	HOW TO INSTALL YOUR SMOKE ALARM
p.6-7	WEEKLY TESTING OF YOUR SMOKE ALARM
p.7	TAKING CARE OF YOUR SMOKE ALARM
p.7-8	REPLACING THE BATTERY
p.8	USING THE TAMPER RESIST LOCKING MECHANISM
p.9	SPECIAL SMOKE ALARM FEATURES
p.10	WARRANTY INFORMATION
p.10	WHERE TO SEND YOUR SMOKE ALARM FOR SERVICE

IMPORTANT INFORMATION ABOUT YOUR SMOKE ALARM

- Before installing your smoke alarm, you must read this entire Owner's Manual.
- This alarm incorporates the internationally recognized horn signal for evacuation. During alarm mode, the horn produces three short beeps followed by a 2 second pause and then repeats. This pattern is somewhat different than the previous alarm sound, which continually beeped.
- Install a smoke alarm in each room and area of your home. See "WHERE YOU SHOULD INSTALL YOUR SMOKE ALARMS."

- Smoke alarms cannot give you an early warning of fire or smoke unless you install, use and maintain them by following these instructions.
- You must hear the alarm's warning sound and quickly respond to it to reduce the risk of damage, injury or death that may result from a fire.
- Your smoke alarm is packaged with the battery disconnected. Connect it to the battery leads before mounting the smoke alarm.
- A smoke alarm will not work without a good battery installed correctly. The smoke alarm must be tested when a new battery is installed and every week after that.
- A smoke alarm that beeps about once per minute means the battery is weak, and you need a new battery.
- A smoke alarm should never be used, in any case, for more than 10 years.

WHAT SMOKE ALARMS CAN DO

Smoke alarms can only HELP protect your home and family against loss from a fire. The best protection is obtained by installing smoke alarms in each room, and each other area of the home, making sure the people in the home will be able to hear and respond to the alarm sound.

Your smoke alarm meets or exceeds the requirements for audibility, or loudness, set by Underwriters' Laboratories, Inc.

!WARNING: SMOKE ALARMS MAY GIVE YOU A WARNING OF FIRE AND SMOKE, BUT ONLY IF YOU INSTALL, USE AND MAINTAIN THEM IN ACCORDANCE WITH THESE INSTRUCTIONS.

WHAT SMOKE ALARMS WILL NOT DO

A SMOKE ALARM WILL NOT WORK WITHOUT POWER. Your smoke alarm needs a good battery that is installed correctly to work. A smoke alarm will not work if its battery is missing, dead or put in wrong.

A SMOKE ALARM WILL NOT SENSE A FIRE WHEN THE SMOKE CANNOT REACH THE ALARM. If a fire starts in a chimney, wall, roof, the other side of a closed door, or any other isolated area, the smoke alarm may not sense the smoke and will not give a warning. If you do not have an alarm in the bedroom, and sleep with the door closed, a fire inside the bedroom may not sound the alarm located in another room. Therefore, a smoke alarm must be placed both inside and outside all bedrooms. **A SMOKE ALARM WILL NOT PROMPTLY SENSE A FIRE EXCEPT IN THE AREA OR ROOM IN WHICH THE SMOKE ALARM IS LOCATED.**

FOR EXAMPLE:

- A SMOKE ALARM MAY NOT SENSE A FIRE ON ANOTHER LEVEL OF A RESIDENCE OR BUILDING. A second-floor smoke alarm may not detect a fire on the first floor or in the basement of a building. Therefore, smoke alarms must be installed on every floor or level of your home or building.
- IF THE SMOKE ALARM IS LOCATED ON A DIFFERENT LEVEL THAN THE BEDROOMS, OR IN AN ISOLATED AREA OF THE HOUSE OR RESIDENCE, IT IS LESS LIKELY TO WAKE UP PEOPLE SLEEPING IN THE BEDROOMS.

ALL TYPES OF SMOKE ALARMS HAVE LIMITATIONS. NO TYPE OF SMOKE ALARM CAN SENSE EVERY KIND OF FIRE OR SMOKE EVERY TIME.

Ionization smoke alarms are your best overall choice for reliability and fast response time (NFP Research Foundation and U.S. Fire Administration Data) since they quickly sense small "invisible" smoke particles and also sense large "visible" smoke particles. Note, photoelectric smoke alarms may respond faster in certain types of fires, for example slow smoldering fires with large "visible" smoke particles. For additional protection the NFPA recommends the use of multiple smoke alarms and heat detectors.

You should use both battery-powered and direct-wired 120-volt AC-powered smoke alarms. Since A SMOKE ALARM WILL NOT WORK WITHOUT POWER, having alarms that will work from two different power sources can give you extra protection in case of a dead battery, or an AC power failure.

Using a smoke alarm in a smoky area like a kitchen, or in a high humidity area near a shower, can cause false alarms. DO NOT REMOVE YOUR BATTERY TO QUIET THE ALARM. DO NOT TAKE THE ALARM DOWN. DO NOT SHUT OFF THE POWER TO THE ALARM. IF YOU HAVE A FALSE ALARM, TRY WAVING A TOWEL NEAR THE ALARM TO CLEAR THE SENSING CHAMBER. A SMOKE ALARM WILL NOT HELP PROTECT YOU IF IT IS NOT POWERED, OR THE UNIT IS REMOVED. An alarm with a FALSE ALARM CONTROL feature should be used to minimize these nuisance alarms, where allowed by state and local codes.

A SMOKE ALARM MAY NOT ALWAYS WARN YOU ABOUT FIRES CAUSED BY CARELESSNESS OR SAFETY HAZARDS SUCH AS SMOKING IN BED, VIOLENT EXPLOSIONS, ESCAPING GAS, IMPROPER STORAGE OF FLAMMABLE MATERIALS, OVERLOADED ELECTRICAL CIRCUITS, NATURAL CAUSES SUCH AS LIGHTNING, CHILDREN PLAYING WITH MATCHES AND ARSON. Fire prevention is your best safeguard.

Installing smoke alarms may make you eligible for lower insurance rates, but SMOKE ALARMS ARE NOT A SUBSTITUTE FOR INSURANCE. Home-owners and renters alike should continue to insure their lives and properties.

WHERE YOU SHOULD INSTALL YOUR SMOKE ALARMS

The National Fire Protection Association's (NFPA) Standard 74, Section 2-1 provides information regarding the smoke detection equipment required within the family unit.

Section 2-1.1.1 reads as follows:

"Smoke detectors shall be installed outside of each separate sleeping area in the immediate vicinity of the bedrooms and on each additional story of the family living unit including basements and excluding crawl spaces and unfinished attics.

The provisions of 2-1.1.1 represent the minimum number of detectors required by this standard. It is recommended that the householder consider the use of additional smoke or heat detectors for increased protection for those areas separated by a door from the areas protected by the required smoke detectors under 2-1.1.1 above. The recommended additional areas are the living room, dining room, bedroom(s), kitchen, attic (finished or unfinished), furnace room, utility room, basement, garage (attached or unattached), and hallways not included in Section 2-1.1.1 above. However, the use of additional detectors remains the option of the householder."

This equipment should be installed in accordance with the National Fire Protection Association's Standard 74, NFPA, Batterymarch Park, Quincy, MA 02269.

THIS STANDARD MEANS YOU SHOULD INSTALL AND USE A SMOKE ALARM IN EVERY ROOM AND AREA OF YOUR HOUSEHOLD OR BUILDING FOR GOOD PROTECTION.

THE FOLLOWING INFORMATION WILL HELP YOU SAFELY LOCATE YOUR SMOKE ALARMS:

- Do install your smoke alarms in accordance with all applicable laws, regulations, standards and codes.
- Do install a smoke alarm in the hallway outside of every bedroom area. If the bedroom has a door, there must be a smoke alarm inside and outside the bedroom. See Figure 1. If your home or residence has two bedroom areas, a smoke alarm must be placed outside the second bedroom area, and inside the bedroom(s) if they have doors. See Figure 2.

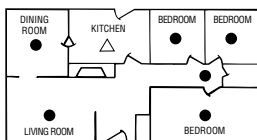

FIGURE 1

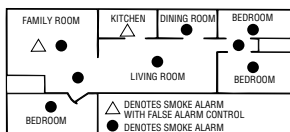

FIGURE 2

IF YOUR HOUSEHOLD OR RESIDENCE HAS SEVERAL FLOORS, THERE MUST BE AN ALARM ON EVERY FLOOR, INCLUDING IN THE BASEMENT. See Figure 3.

- Do install a smoke alarm in every bedroom where a smoker sleeps.
- Do install a smoke alarm in every room and bedroom where electrical appliances (such as portable heaters, humidifiers or electric blankets) may be operated while someone sleeps.
- Do install a smoke alarm inside every bedroom where someone sleeps with the door closed. Smoke can be blocked by the closed door, or the alarm may not wake the sleeper if the door is closed.
- Do install smoke alarms at both ends of a bedroom hallway if it is more than 30 feet long.
- Do install basement smoke alarms at the bottom of the basement stairwell.
- Do install second floor smoke alarms at the top of the first-to-second floor stairwell, as long as no door or obstruction blocks the path of the smoke to the alarm.
- Do install a smoke alarm in a room where flammable household chemicals or solvents are stored. For example, if you keep kerosene, paint thinner or certain types of contact cements within your residence, install a smoke alarm in that room, unless not recommended by a situation described in the section "WHERE YOU SHOULD NOT INSTALL SMOKE ALARMS."
- Do install smoke alarms on the ceiling not closer than 4 inches to any wall or corner, or on the wall at least 4 inches but no more than 12 inches from the ceiling. See Figure 4.

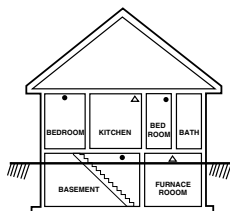

FIGURE 3

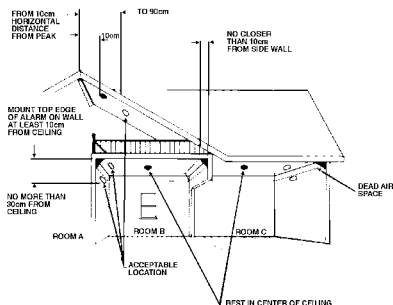

FIGURE 4

- If your ceiling has radiant heat or has a lack of insulation to the outside, ceiling mounting of your smoke alarm is not advisable due to temperature variations. You should follow the wall-mounting procedures.

- If you have a peaked, sloped, gabled or cathedral-style ceiling, mount your smoke alarm 4 to 36 inches (3 feet) MEASURED HORIZONTALLY FROM THE HIGHEST POINT ON THE CEILING, as shown in Figure 4.
- Do install smoke alarms in both rooms (areas) that are divided by a partial wall extending 8 or more inches down from the ceiling. See smoke alarms located in rooms B and C in Figure 4.

SPECIAL DIRECTIONS FOR INSTALLING YOUR SMOKE ALARM IN MANUFACTURED AND MOBILE HOMES

!WARNING: SMOKE ALARMS MAY BE INSTALLED ON THE CEILINGS OF MANUFACTURED AND MOBILE HOMES IF THERE IS ADEQUATE INSULATION IN THE CEILING.

Install smoke alarms on walls only between 4 and 12 inches from the ceiling. Install smoke alarms on inside walls in older homes or in homes where you are not sure of the insulation level. In older homes (manufactured in approximately 1976 or before) that have little or no insulation compared to today's standards, uninsulated metal outside walls and roofs can transfer heat and cold from the outdoors, making the air right next to the wall or roof hot or cold, compared to the rest of the air inside the room. These layers of hot or cold air can prevent smoke from reaching a smoke alarm. If your mobile home has this condition, put your smoke alarm on an inside wall only, between 4 and 12 inches from the ceiling. If you are not sure about the insulation in your mobile home or if you notice the outside walls or ceiling are unusually hot or cold, put the smoke alarm on an inside wall.

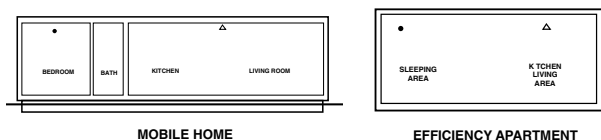

FIGURE 5: EFFICIENCY APARTMENT AND MOBILE HOME INSTALLATION

WHERE YOU SHOULD NOT INSTALL SMOKE ALARMS

- Do not install a smoke alarm within close proximity of heating and cooling supply vents or within close proximity of return or fresh air vents. Smoke may be blown away from the smoke alarm by the supply vents, or could be diffused or reduced by being diverted into the return air vent. The NFPA states in Standard 72E, Section 4-4.1: "In rooms, buildings, where forced ventilation is present, detectors shall not be located where air from supply diffusers ("vents") could dilute smoke before it reaches the detector."
- Do not install your smoke alarm in an area where the temperature may fall below 40°F, or rise above 100°F. Smoke alarms are designed to work safely only within these temperature ranges, and failure to alarm, improper alarms or nuisance alarms may result from operation outside these temperature limits.
- Do not install a smoke alarm in a damp or very humid areas such as bathrooms with showers, where the normal humidity may rise above 93% relative humidity. Above this level, moisture may condense inside the smoke chamber and cause wrong or false alarms.
- Do not install a smoke alarm in an area where particles of combustion are normally present, such as kitchens or automobile garages, unless the smoke alarm has a False Alarm Control feature.

Continued on page 6

IMPORTANT INFORMATION SMOKE ALARM SAFETY CHECKLIST

***PIN THIS UP CLOSE TO YOUR SMOKE ALARM IN AN
EASY-TO-READ LOCATION AND REVIEW BOTH SIDES OFTEN***

Before installing, using and maintaining your smoke alarm read the entire Owner's Manual and Warranty, and keep it in a convenient location for reference.

1. Test your smoke alarm every week. To test the electronics, firmly depress the button. To test that smoke reaches the sensor, blow smoke in a careful fire-safe manner into your smoke alarm.
2. Your smoke alarm will not work without power. Never shut off its power or remove the battery to quiet the alarm.

FOR BATTERY-POWERED UNITS: When your smoke alarm "beeps" about once a minute, the battery is weak. Immediately install a new battery correctly. Be sure to use only batteries specified in Owner's Manual or on unit. Test unit after installing a new battery.

3. Clean and vacuum the openings on your smoke alarm once a month.
4. Do not open the smoke alarm or try to repair it. For replacement information see the WARRANTY in the Owner's Manual.
5. Verify you have the proper number of smoke alarms in your home and the correct location for each one. A smoke alarm will not respond well in an incorrect location.
6. If your smoke alarm has one or more of these special features, please note:
 - **FALSE ALARM CONTROL (Model C):** Pushing test/hush button reduces sensitivity for up to 15 minutes, minimizing nuisance alarms.
 - **FLASHING LIGHT (Model E):** Pushing test button turns flashing safety light on. Very thick smoke may obscure light.
7. Smoke alarms have technical limitations and may not respond in all situations. **FIRE PREVENTION** is your best safeguard.
8. For a replacement Owner's Manual or Safety Checklist, please indicate your unit model, include a self-addressed stamped envelope and send to:

Maple Chase Company
2820 Thatcher Road
Downers Grove, Illinois 60515-4040

For product service information please see WARRANTY in Owner's Manual.

OTHER THINGS YOU CAN DO TO MAKE YOUR FAMILY AND HOME SAFER FROM FIRES

Installing, testing and taking care of smoke alarms is just one step in helping to protect your family and home from fires. You must also reduce the chance that fire will start in your home and increase your chances of escaping if one does start. For your safety, at a minimum, you should do the following to have a more effective fire safety program.

A. FOLLOW SAFETY RULES AND PREVENT HAZARDOUS SITUATIONS

- Use smoking materials properly—never smoke in bed or when sleepy or under the influence of alcohol or other drugs.
- Keep matches and other fire starters away from children.
- Store flammable materials in proper containers and never store or use them near open flames or sparks.
- Keep electrical appliances and cords in good working condition, and do not overload electrical circuits.
- Keep stoves, fireplaces, chimneys and barbecue grills clean and make sure they are properly installed away from combustible materials.
- Keep portable heaters and open flames such as candles away from combustible materials.
- Do not allow rubbish to accumulate.

B. DEVELOP A FAMILY ESCAPE PLAN AND PRACTICE IT REGULARLY WITH YOUR ENTIRE FAMILY ESPECIALLY SMALL CHILDREN

- Draw a floor plan of your home and find TWO ways to exit from each room. There should be a way to get out of each bedroom without opening the door.
- Teach children what the smoke alarm signal means, and that they must be ready to leave the home or residence by themselves if necessary. Show them how to check to see if doors are hot before opening them, how to stay close to the floor and crawl, and how to use the alternate exit if a door is hot and should not be opened.
- Decide on a meeting place a safe distance from your house and make sure all your children understand they should go and wait for you there if there is a fire.
- Hold fire drills every six (6) months to make sure everyone, even small children, know what to do to escape safely.
- Know where to go to call the fire department from outside your residence.
- Provide emergency equipment, such as fire extinguishers, and teach your family how and when to use this equipment.

C. WHAT TO DO IF THERE IS A FIRE IN YOUR HOME

After you have prepared family escape plans and practiced them with your family, you have increased their chances of escaping safely. Review the following rules with your children when you have fire drills so everyone will remember them in a real smoke or fire emergency.

- Don't panic; stay calm. Your safe escape may depend on thinking clearly and remembering what you have practiced.
- Get out of the house following your planned escape route as quickly as possible. Do not stop to collect anything or to get dressed.
- Open doors carefully only after feeling to see if they are hot. Do not open a door if it is hot; use an alternate escape route.
- Stay close to the floor; smoke and hot gases rise toward the ceiling.
- Keep doors and windows closed unless you open them to escape and reclose them as you leave.
- Meet at your prearranged meeting place after leaving the house.
- Call the fire department as soon as possible from outside your house. Give the address and your name.
- Never re-enter a burning or smoke-filled building.

Contact your local fire department for more information on making your home safer from fires and about preparing your family's escape plans.

- Do not install a smoke alarm in dusty or dirty areas; **SUCH AN INSTALLATION CANNOT BE RELIED UPON.** An accumulation of dust and dirt in the sensing chamber may block the openings and prevent an alarm, or may get inside the alarm and cause false alarms. If a smoke alarm is required in such an area, vacuum it frequently and test it according to the section "TAKING CARE OF YOUR SMOKE ALARM."
- Do not install a smoke alarm in the dead air space in the corner where the wall meets the ceiling. If in doubt as to the exact location of mounting, for your safety, contact your local fire department for help in choosing a location.
- Do not install a smoke alarm where bugs or insects are present before eliminating or minimizing the bug problem. Although all smoke alarms built since 1986 are made to help prevent bugs from entering the detection chamber, bugs may build up on chamber openings and prevent smoke from entering. As a result, unit should be vacuumed frequently as explained in the section "TAKING CARE OF YOUR SMOKE ALARM."
- Do not install a smoke alarm within close proximity of a fluorescent light. Electrical "noise" may cause nuisance alarms.

HOW TO INSTALL YOUR SMOKE ALARM

AFTER HAVING CAREFULLY READ THE FIRST FIVE SECTIONS OF THIS MANUAL, YOU ARE READY TO INSTALL YOUR SMOKE ALARM.

PLEASE FOLLOW THESE DIRECTIONS:

1. Unlock and remove mounting bracket from smoke alarm with a counterclockwise twist.
2. Place mounting bracket on ceiling or wall in prearranged location and use pencil to trace two opposing hole positions for mounting screws. Drill two 1/16-inch holes.
3. Use mounting screws provided for attaching to studs or woodwork. For plaster or plasterboard, you may wish to use plastic anchors and screws. See Figure 6.
4. Screw mounting bracket to surface securely. **NOTE:** Before mounting alarm on a wall, be sure arrow on mounting bracket is pointing up toward ceiling. See Figure 6.
5. Install battery. (See "REPLACING THE BATTERY.")
6. Attach smoke alarm to mounting bracket with a clockwise twist until it snaps into locked position. **NOTE:** Your smoke alarm is designed with a safety mechanism that prevents mounting unless a battery is installed. This helps assure the alarm is functional when mounted.
7. You have now finished installing your smoke alarm. For your safety, proceed with testing described in the next section.

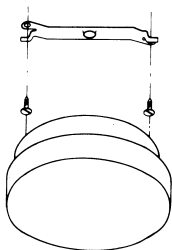

FIGURE 6

WEEKLY TESTING OF YOUR SMOKE ALARM

1. FOR A COMPLETE WEEKLY TEST OF THE ELECTRONICS AND THE SENSOR OPERATION, FIRMLY DEPRESS THE TEST BUTTON ON THE COVER OF THE SMOKE ALARM FOR A FEW SECONDS. The smoke alarm will sound 3 short beeps followed by a 2-second pause and then repeats. On models with a LED (light emitting diode) the indicator light under the clear Push-to-Test button will blink once per

second while the button is being pushed and the alarm is sounding. The smoke alarm will stop sounding when you release the button.

2. If your smoke alarm has the False Alarm Control or Safety Light feature see "SPECIAL SMOKE ALARM FEATURES" for further testing information.
3. **IMPORTANT:** Always test your smoke alarm upon returning from vacation, or any other time when no one has been in your household or residence for several days.
4. If a smoke alarm is installed in a mobile home, test the smoke alarm after you remove the vehicle from storage and before each trip.

!WARNING: If YOUR SMOKE ALARM DOES NOT RESPOND AS DESCRIBED IN ANY OF THE ABOVE TESTS, CHECK THAT A GOOD BATTERY IS PROPERLY INSTALLED. If A GOOD BATTERY IS PROPERLY INSTALLED, PROMPTLY REMOVE THE UNIT, REPACK IT AND RETURN IT FOR REPAIR OR REPLACEMENT (SEE SECTION "WHERE TO SEND YOUR SMOKE ALARM IF IT NEEDS SERVICE").

TAKING CARE OF YOUR SMOKE ALARM

Your smoke alarm has been designed and manufactured to be as maintenance-free as possible. Here are a few simple steps you must perform, in addition to the weekly tests described in the section "WEEKLY TESTING OF YOUR SMOKE ALARM," to keep your unit in good working order.

- The smoke alarm should be vacuumed monthly or more often if there is dust, dirt or kitchen grease that can accumulate. Use a soft brush or wand attachment and vacuum all slots in the cover and side. **FOR YOUR SAFETY, you must properly clean and maintain your smoke alarm, since a dirty or malfunctioning unit may fail to alarm or cause unwanted nuisance alarms.**
- If the unit is damaged or fails to operate properly, and you have checked that a good battery is installed correctly, follow the directions in the section "WHERE TO SEND YOUR SMOKE ALARM IF IT NEEDS SERVICE" for return. **FOR YOUR SAFETY, DO NOT OPEN THE SMOKE ALARM AND TRY TO REPAIR IT YOURSELF.** While smoke alarms are economical devices, they contain precision electronic components that are precisely calibrated. Repair must be done by the manufacturer.

REPLACING THE BATTERY

The smoke alarm will "beep" once a minute for at least 30 days when the battery is weak. The battery must **immediately** be replaced with a fresh one.

The battery should also be changed if it does not sound an alarm when tested.

TO REPLACE THE BATTERY:

1. Check if the tamper resist locking pin is installed in the smoke alarm (see "USING THE TAMPER RESIST LOCKING MECHANISM" section). If so, pull the pin completely out of the smoke alarm using long-nose pliers.
2. Remove the smoke alarm from the mounting bracket by twisting counterclockwise.
3. Replace old battery with a fresh one. If your smoke alarm has a safety light, the miniature lamp operates on two AA batteries. (See recommended batteries below.)
4. Check that battery connections are secure and the battery is secured in its compartment.

5. Test smoke alarm for proper operation (see "WEEKLY TESTING OF YOUR SMOKE ALARM" section). The smoke alarm operates on a 9-volt battery. The normal battery operating life will be one (1) year. The life of some batteries may be less.
6. Firex smoke alarms sold with Ultralife long-life lithium batteries require replacement approximately every ten (10) years. Replace the battery approximately every ten (10) years or when the low battery signal sounds.

!CAUTION: YOU SHOULD ONLY USE THE BATTERIES SPECIFIED HERE OR ON THE LABEL OF THE UNIT.

For Models A, B, C, E and PB use: Eveready 216, 522 or 1222; Mallory MN1604; Duracell MN1604; or Ultralife U9VL-J.

For Model E also use AA Heavy Duty for light power. The miniature lamp operates on two (2) AA batteries. For replacement, use heavy-duty or alkaline AA batteries: Eveready 1215, E91, or Duracell M15HD, MN1500.

!CAUTION: DO NOT USE ANY TYPE OF RECHARGEABLE BATTERIES.

USING THE TAMPER RESIST LOCKING MECHANISM

To make the smoke alarm somewhat tamper resistant, a "locking pin" has been provided in the base of the unit. It will help deter a child or other individual from removing the smoke alarm from the bracket. See Figure 7. This can be installed by the following directions.

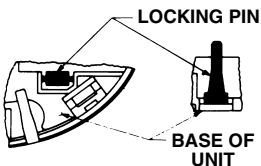

FIGURE 7

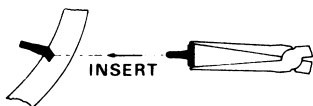

FIGURE 8

1. Remove the break-away locking pin from the unit by rocking pin back and forth.
2. Put the smoke alarm back on the mounting bracket. (See section "HOW TO INSTALL YOUR SMOKE ALARM.")
3. Using long-nose pliers, grab the head of the locking pin and insert into hole located on the side of the smoke alarm. See Figure 8.
4. The Tamper Resist feature is now installed and complete.

To Remove:

5. Using long-nose pliers, grasp the head of the locking pin and pull the pin completely out of the smoke alarm.
6. The smoke alarm can now be removed from the mounting bracket with a counterclockwise twist.

SPECIAL SMOKE ALARM FEATURES

If your smoke alarm has one or more of these special features, read the following:

- **BLINKING LED LIGHT (Models B, C, E and PB):** The indicator light under the Push-to-Test button blinks about once per minute to indicate the smoke alarm is receiving power.
- **FALSE ALARM CONTROL (Model C):** Simply push the test button to temporarily silence the smoke alarm if a nuisance alarm occurs or to prevent nuisance alarms. By momentarily depressing the test button, your alarm will automatically switch to a special "Reduced Sensitivity" condition for up to 15 minutes, after which it will reset to its full normal sensitivity. If a real fire occurs, however, and the quantity of smoke reaching the smoke alarm is sufficiently great, the unit will sound an alarm. The "Reduced Sensitivity" level is only intended to eliminate nuisance alarms caused by light concentrations of smoke. If additional "Reduced Sensitivity" time is required, push the button again. Every time the smoke alarm is tested it will enter the "Reduced Sensitivity" condition for up to 15 minutes and then automatically switch back to full normal sensitivity.
- **SAFETY LIGHT (Model E):** This smoke alarm uses a miniature lamp designed to last for an average of 15 hours of continuous operation. When you push the test button the light will flash along with the alarm sounding to indicate it is working properly.

!WARNING: VERY THICK SMOKE MAY OBSCURE THE LIGHT.

WARRANTY INFORMATION

5-YEAR LIMITED SMOKE ALARM WARRANTY AND 10-YEAR LIMITED ULTRALIFE U9VL-J LITHIUM BATTERY WARRANTY (WHEN SOLD WITH MAPLE CHASE COMPANY SMOKE ALARM)

Maple Chase Company warrants to the original consumer purchaser each new smoke alarm to be free from defects in material and workmanship under normal use and service for a period of five (5) years from the date of purchase. For Maple Chase Company smoke alarms sold with an Ultralife U9VL-J 9-volt battery, Maple Chase Company warrants to the original consumer purchaser each new Ultralife U9VL-J 9-volt battery to be free from defects in material and workmanship under normal use and service for a period of ten (10) years from the date of purchase. Maple Chase Company agrees to repair or replace, at its option, any defective smoke alarm or Ultralife U9VL-J 9-volt battery (when sold with Maple Chase smoke alarm) provided that it is returned with postage prepaid and with proof of purchase date to Maple Chase Company. This warranty does not cover damage resulting from accident, misuse or abuse or lack of reasonable care of the product. This warranty is in lieu of all other express warranties, obligations or liabilities. THE IMPLIED WARRANTIES OF MERCHANTABILITY AND FITNESS FOR A PARTICULAR PURPOSE ARE LIMITED TO A PERIOD OF FIVE (5) YEARS FOR THE SMOKE ALARM AND TEN (10) YEARS FOR THE ULTRALIFE LITHIUM U9VL-J 9-VOLT BATTERY (WHEN SOLD WITH MAPLE CHASE SMOKE ALARM) FROM PURCHASE DATE. Some states do not allow limitations on how long an implied warranty lasts, so the above limitations may not apply to you. IN NO CASE SHALL MAPLE CHASE COMPANY BE LIABLE FOR ANY INCIDENTAL OR CONSEQUENTIAL DAMAGES FOR BREACH OF THIS OR ANY OTHER WARRANTY, EXPRESS OR IMPLIED, WHATSOEVER, EVEN IF THE LOSS OR DAMAGE IS CAUSED BY ITS NEGLIGENCE OR FAULT. Some states do not allow the exclusion or limitation of incidental or consequential damages, so the above limitation or exclusion may not apply to you. This warranty gives you specific legal rights, and you may also have other legal rights which vary from state to state.

This smoke alarm's manufacture and distribution are licensed by the U.S. Nuclear Regulatory Commission.

This product meets all the requirements of U.L. Standard 217.